

Monteringsanvisning 30 DK :

1. Markera koordinators placering på karmöverstycke. (Alt. på konsol 31 DK.) Koordinator skall monteras så den tillser att passivt dörrblad passerar aktivt dörrblad som spärras av koordinatör.
2. Borra hål för montage (3x). Montera koordinatör. Dra skruvar. Används utfyllnadsprofil, skall denna kapas till rätt längd och monteras.
3. Markera placering för skyddsplattor på båda dörrbladen, mitt för koordinators nockar. Borra hål för montage (2x / platta). Montera skyddsplattor. Dra skruvar.
4. Kontrollera koordinators funktion.

Monteringsanvisning 33 DK :

5. Märk ut placering på passivt dörrblad.
6. Märk ut samt borra hål för montage (2x).
7. Applicera skyddsgummi. Gör hål för skruvar i skyddsgummit.
8. Montera medbringare. Dra skruvar.
9. Kontrollera systemets funktion. Medbringare ska tillse att aktivt dörrblad öppnas tillräckligt för att aktivera koordinatör.

Förpackningarna innehåller:

Dörrkoordinator 30 DK

Skyddsplatta (2 st.)

Skruv för montage av koordinatör (3 st.)

Skruv för montage av skyddsplattor (4 st.)

Art.Nr: grå: 471014430-850(-1150)/GR

galvaniserad: 471014430-850(-1150)/GALV

Konsol 31 DK (3 st.) Art.Nr: 471014431

Medbringare 33 DK

Skyddsgummi, Skruv för montage (2 st.)

Art.Nr: vit: 471014433/WT

grå: 471014433/GR

①

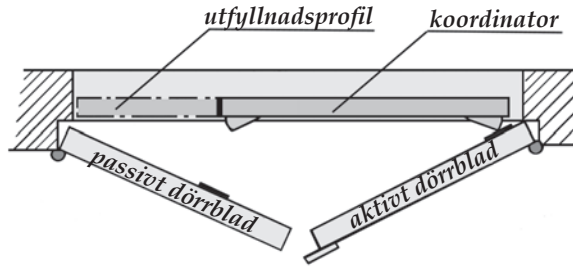

②

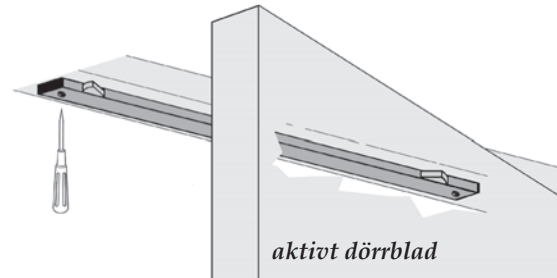

③

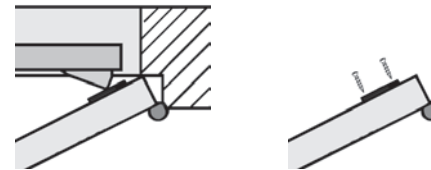

④

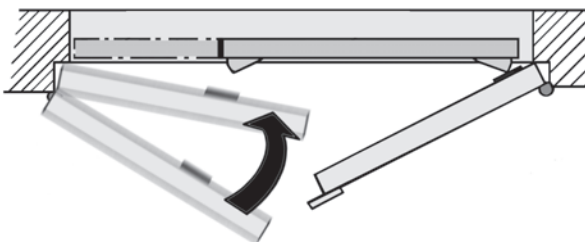

Vid montage bakom karmöverstycke används tillbehör: 31 DK - Konsol.

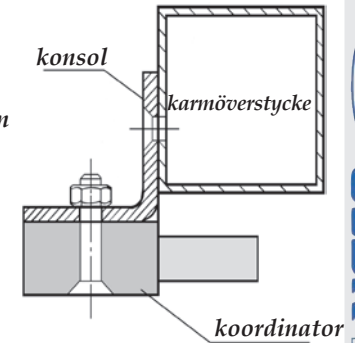

⑤

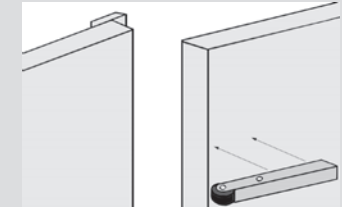

⑥

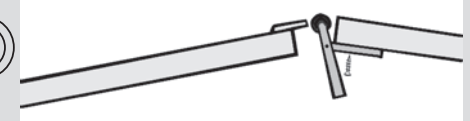

⑦

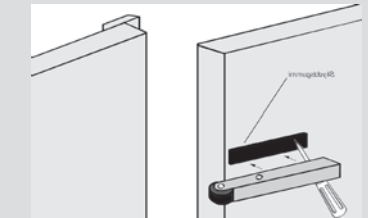

⑧



⑨

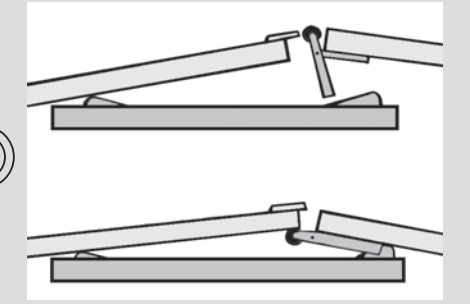

Mounting instructions 30 DK :

1. Mark the position of the coordinator on the top of the frame. (Alt. on Bracket 31 DK.)
The coordinator is fitted so that the passive door-leaf can pass the active door-leaf which is stopped by the coordinator.
2. Drill holes for fitting (3x).
Mount the coordinator. Tighten the screws. If an additional profile is used, it should be cut to the correct length and mounted.
3. Mark the position of the protection plates on both door-leaves, in line with the latches of the coordinator. Drill holes for fitting (2x / plate). Mount the protection plates. Tighten the screws.
4. Check the function of the coordinator.

Mounting instructions 33 DK :

5. Mark the position on the passive door-leaf.
6. Mark and drill holes for fitting (2x).
7. Fit the protection rubber.
Make holes for screws in the rubber.
8. Mount the carry open. Tighten the screws.
9. Check the function of the system.
The carry open should ensure that the active door-leaf is carried open, enough to activate the coordinator.

Packages contains:

Door coordinator 30 DK
 Protection plates (2 pcs.)
 Screws for fitting of coordinator (3 pcs.)
 Screws for fitting of protection plates (4 pcs.)
 Art.No: grey: 471014430-850(-1150) / GR
 galvanized: 471014430-850(-1150) / GALV
 Bracket 31 DK (3 pcs.) Art.No: 471014431
 Carry open 33 DK
 Protection rubber, screws for fitting (2 pcs.)
 Art.No: white: 471014433 / WT
 grey: 471014433 / GR

①

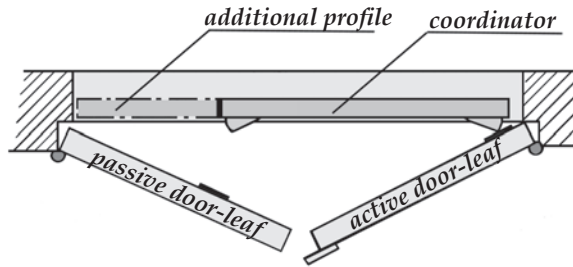

②

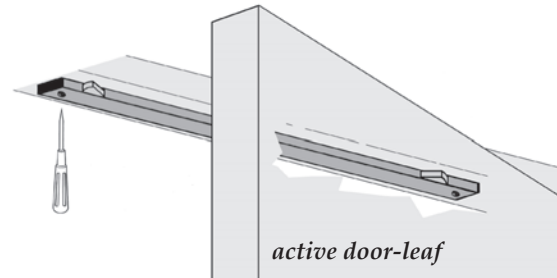

③

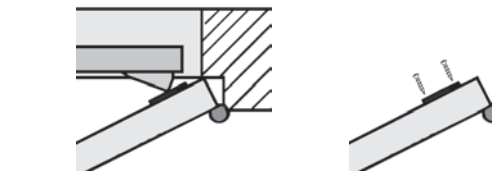

④

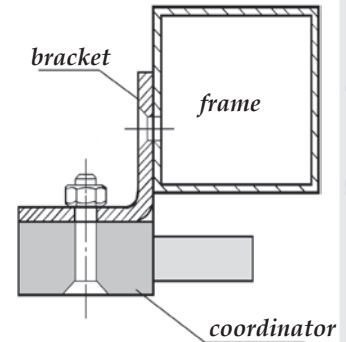
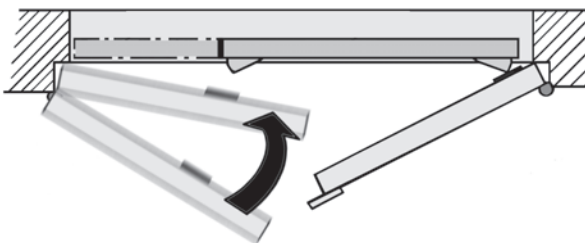

When fitting on the rear side of the top of the frame, use accessory: 31 DK - Bracket.

⑤

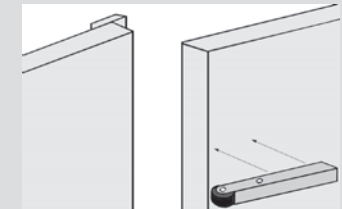

⑥

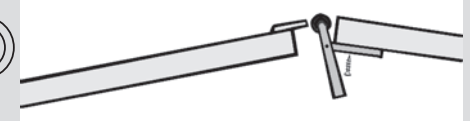

⑦

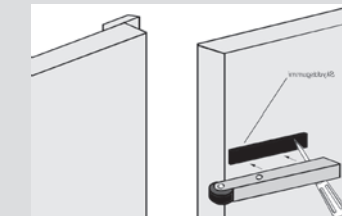

⑧



⑨

