

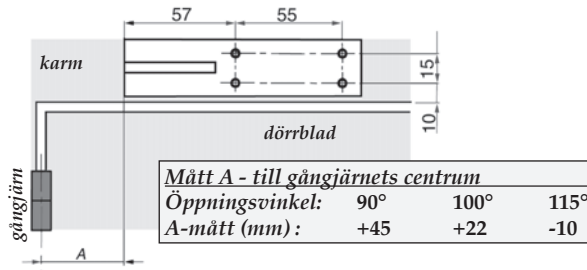

Monteringsanvisning 73 DS och 77 DA :

1. Markera placeringen av dörrstopp på karm - se tabell / mall.
2. Borra för montage (4x).
3. Montera dörrstopp.
Dra skruvar.
4. Anbringa dörrhållare på dörrstoppets axel.
5. Markera samt borra för montage på dörrblad (2x).
6. Montera dörrhållare.
Dra skruvar.
7. Kontrollera dörrstoppets funktion tillsammans med dörrhållare.

①

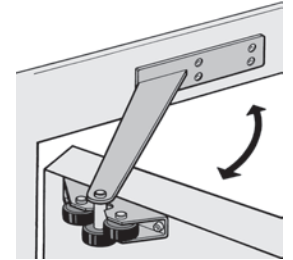

⑦



②

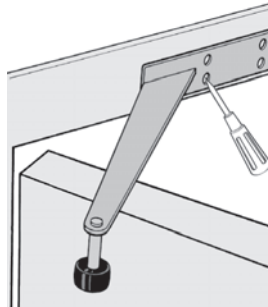

③

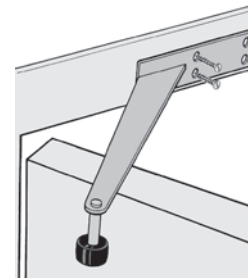

④

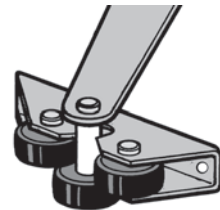

⑤

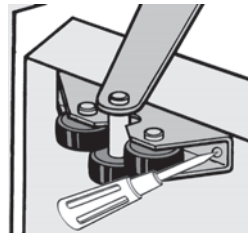

⑥

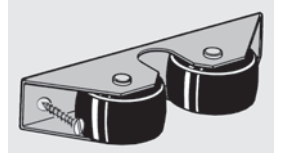
Förpackningarna innehåller:
Dörrstopp 73 DS:

Arm
 Axel med gummihjul
 Mutter och bricka
 Skruv för montage (4 st.)
 Art.Nr: vit: 471014173/WT
 grå: 471014173/GR

Dörrhållare 77 DA

Skruv för montage (2 st.)
 Art.Nr: vit: 471014277/WT
 grå: 471014277/GR

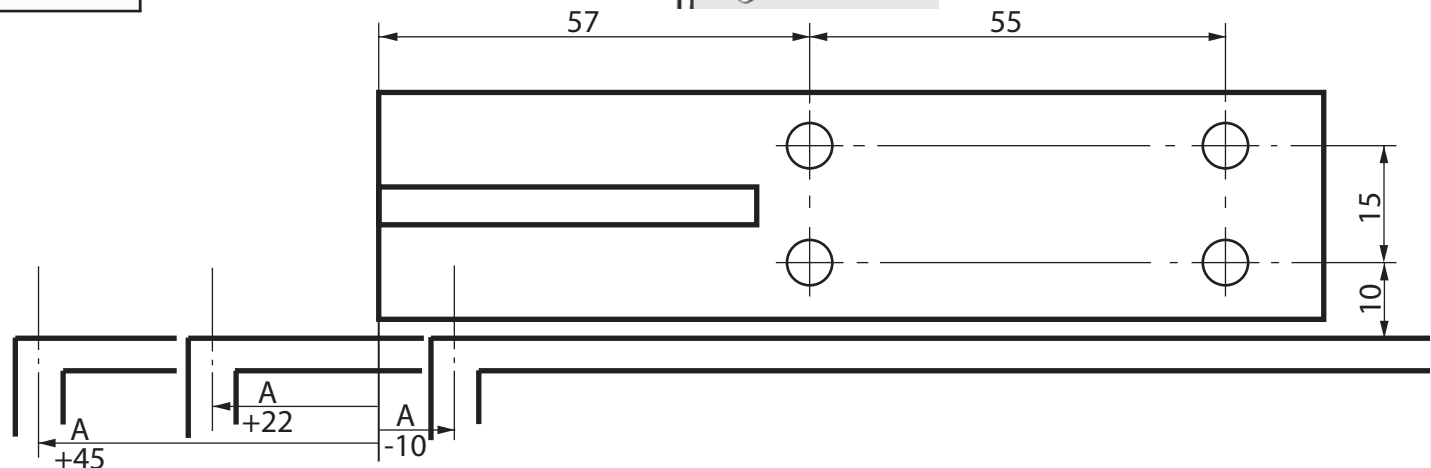



Mounting instructions 73 DS and 77 DA :

1. Mark the position of the opening limiter on the frame - see table / pattern.
2. Drill for fitting (4x).
3. Mount the opening limiter. Tighten the screws.
4. Attach the door fastener on the axis of the opening limiter.
5. Mark and drill for mounting on the door leaf (2x).
6. Mount the door fastener. Tighten the screws.
7. Check the function of the opening limiter together with the door fastener.

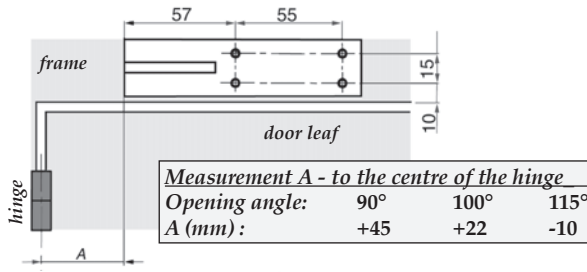
①

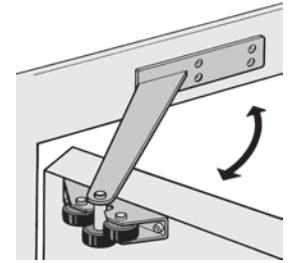

⑦



②

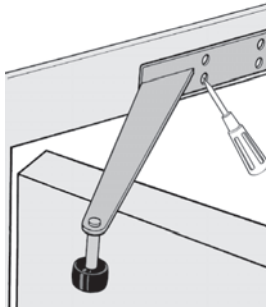

③

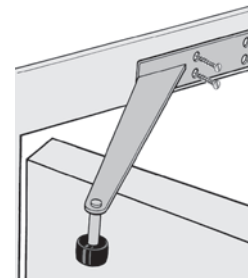

④

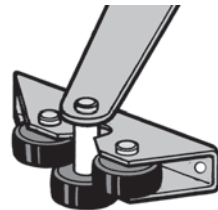

⑤

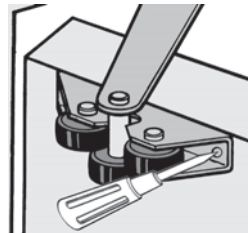

⑥

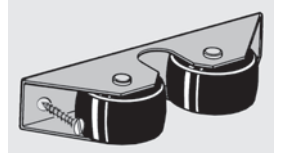
Packages contains:

Opening limiter 73 DS:

Arm

Axis with rubber wheel

Nut and washer

Screws for mounting (4 pcs.)

Art.No:

white: 471014173 / WT

grey: 471014173 / GR

Door fastener 77 DA

Screws for mounting (2 pcs.)

Art.No:

white: 471014277 / WT

grey: 471014277 / GR

