

## **ACTpro 1520e Single Door IP Controller with 12 Volt DC 2A PSU**

## **ACTpro 1500e Single Door IP Controller**



---

---

## **Operating and Installation Instructions**

---

---



The ACTpro 1520e and 1500e are compatible with all ACTpro systems including: 4000 and 4200 controllers.



○.....→

<b>1.0</b>	<b>Typical wiring of ACTpro 1520e/1500e Controllers.....</b>	<b>4</b>
<b>2.0</b>	<b>Adding PIN and/or Proximity Readers .....</b>	<b>5</b>
<b>3.0</b>	<b>Connecting Controller to Ethernet. ....</b>	<b>6</b>
<b>4.0</b>	<b>Defaulting Controller and IP address Configuration.....</b>	<b>7</b>
4.1	Factory Default ACTpro Controller (DIP Switch 2) .....	7
4.2	DHCP/Static IP Addressing (DIP Switch 1) .....	7
4.3	Defaulting the Static IP Address .....	8
4.4	Changing Static IP address on the ACTpro Controller.....	8
<b>5.0</b>	<b>Configuring the PC/Laptop for Static IP address .....</b>	<b>9</b>
<b>6.0</b>	<b>ACTpro 1520e/1500e Controller status indicators .....</b>	<b>10</b>
<b>7.0</b>	<b>Installing ACTEnterprise .....</b>	<b>11</b>
7.1	Download and extract the setup program .....	11
7.2	Installing ACT Enterprise .....	11
<b>8.0</b>	<b>Add controllers to ACT Enterprise.....</b>	<b>12</b>
<b>9.0</b>	<b>Backup/Restore from ACT Enterprise .....</b>	<b>14</b>
<b>10.0</b>	<b>Troubleshooting.....</b>	<b>15</b>
<b>11.0</b>	<b>ACTpro 1520e Installation &amp; Technical Specification .....</b>	<b>16</b>
<b>12.0</b>	<b>Fire Override Configuration.....</b>	<b>19</b>
<b>13.0</b>	<b>Interlock/Airlock Configuration: .....</b>	<b>19</b>
<b>14.0</b>	<b>Intruder Panel Wiring Diagram:.....</b>	<b>20</b>
<b>15.0</b>	<b>Product Specification .....</b>	<b>21</b>
<b>16.0</b>	<b>Ordering Information: .....</b>	<b>22</b>

## ACTpro 1520e PSU Installation guide

The ACTpro 1520e includes an ACT 12V DC 2A power supply unit.

The 2A output current is used to power the controller and supply the battery recharge current. 500mA is reserved for battery recharge and to power the ACTpro Controller. Therefore 1.5A is available to power readers and the lock.

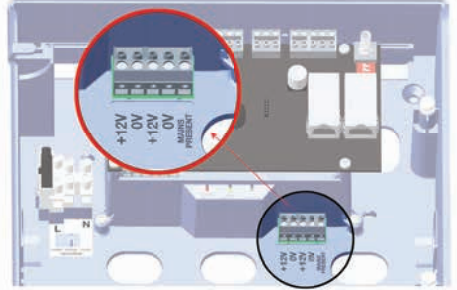

Example: Power budget of a typical single door read in/out installation.

Total Current Available	2000mA
ACTpro Controller and Battery Recharge	500mA
ACT Reader X 2	200mA
Typical Mag Lock	800mA
Total Consumption	1500mA
Spare Capacity	500mA

**Note: See section 11 for ACTpro 1520e Installation & Technical Specification**

## 1.0 Typical wiring of ACTpro 1520e/1500e

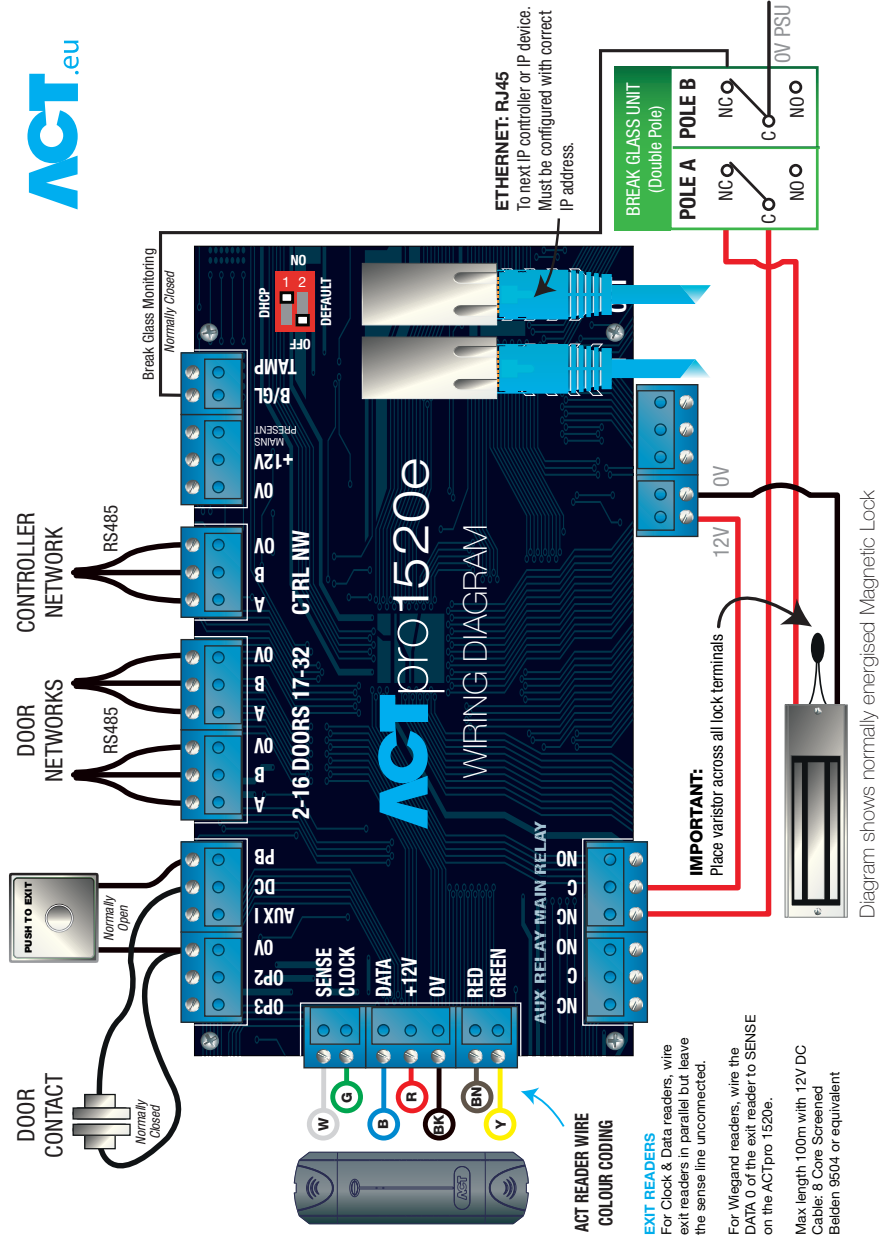

## 2.0 Adding PIN and/or Proximity Readers

### Wiring of entry & exit readers.

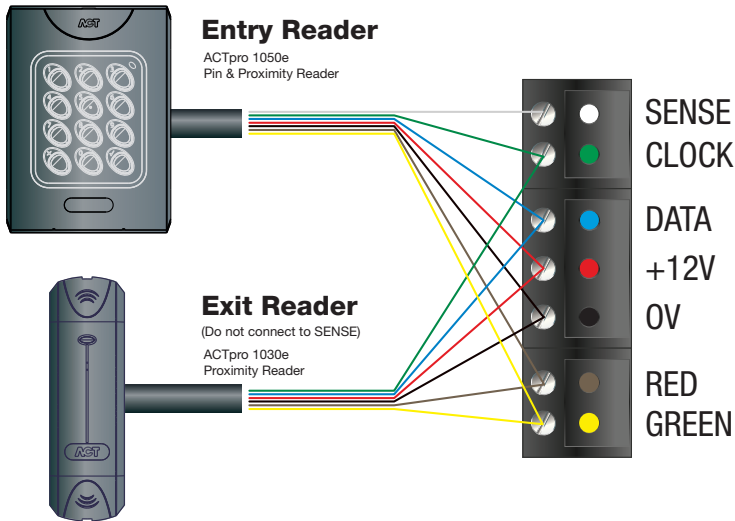

Reader Terminal Block	Recommended wiring colour	Controller input Pin	Signal information
SENSE	White	SENSE	For Entry readers connect the reader SENSE cable or terminal to the SENSE input pin. For Exit readers, do not use this input.
CLOCK	Green	CLOCK	This is the clock or strobe signal input on the ACTpro 1520e/1500e. Connect the reader CLOCK cable or terminal on the reader to CLOCK input pin.
DATA	Blue	DATA	This is the Data input. Connect the reader DATA cable or terminal on the reader to DATA input pin.
+12V	Red	+12V	Positive +12V DC Supply voltage for the reader.
0V	Black	0V	0V Supply Voltage for the reader.
RED	Brown	RED	Red LED control output from the ACTpro 1520e/1500e. Connect the reader brown cable to the terminal marked RED on the controller.
GREEN	Yellow	GREEN	Green LED control output from the ACTpro 1520e/1500e. Connect the reader green cable or terminal marked GREEN on the ACTpro controller.

For Wiegand Entry Readers wire D0 to DATA Pin on ACTpro Controller and D1 to CLOCK pin on ACTpro Controller.

For Wiegand Exit readers wire the D0 of the exit reader to SENSE pin on ACTpro controller and D1 to CLOCK pin on ACTpro Controller.

### 3.0 Connecting Controllers to customer LAN

Each ACTpro Controller can be connected directly to the customer network.

#### Single doors connected over ethernet

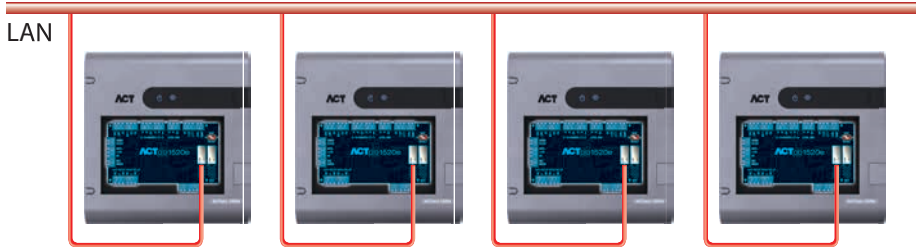

The ACTpro 1520e/1500e Controller has a dual Ethernet switch allowing for the connection of IP devices. Ensure each controller has a unique IP address.

LAN

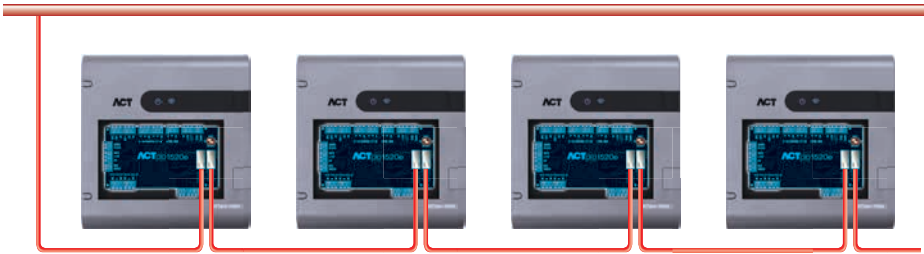

Max distance between devices 100m

### Cabling Chart

From	To	Network Type	Cable Type	Comments
LAN	ACTpro Controller	TCP/IP	Cat5/6	Max distance between network devices is 100m
ACTpro Controller	ACTpro Readers	ACT Protocol	8 core Screen	Max distance 100m
ACTpro 1520e/1500e	ACTpro Controllers	TCP/IP	Cat5/6	Max distance between network devices is 100m

## 4.0 Defaulting Controller and IP Address Configuration

The ACTpro 1520e/1500e have two DIP switches.

- DIP switch 1: DHCP  
Enables DHCP or Static IP address mode.
- DIP switch 2: DEFAULT  
Defaults the controller or the Static IP address.

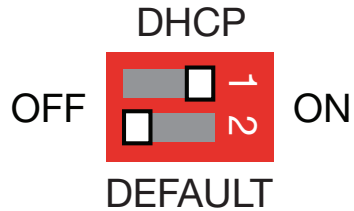

### 4.1 Factory Default controller (*DIP Switch 2*)

The ACTpro Controller may be defaulted to factory settings. This will completely erase the controller memory. All information including card details will be erased and the static IP address will be reset to 192.168.1.60.

To default the ACTpro Controller:

1. Power down the ACTpro Controller.
2. Set the DEFAULT DIP switch 2 to **ON**
3. Hold down the Tamper spring.
4. Apply power to the ACTpro 1520e/1500e controllers.
5. Wait approximately 5 seconds, until the controller confirms default completed by sounding the buzzer.
6. Release the Tamper.
7. Power down the ACTpro controller.
8. Set the Default DIP switch to **OFF**
9. Re-apply power.

### 4.2 DHCP/Static IP Addressing (*DIP Switch 1*)

The ACTpro Controller is shipped with the DHCP enabled and can be configured to obtain an IP address from a DHCP server or use a static IP address.

1. Power down the ACTpro Controller.
2. Set the DIP switch to its new position.
  - a. DHCP IP addressing: Move DIP switch 1 to **ON**
  - b. Static IP addressing: Move DIP switch 1 to **OFF**

**Note:** Default static IP address is **192.168.1.60**

3. Re-apply power to the board.



### 4.3 Defaulting the Static IP address

The static IP address can be reset to the default value of 192.168.1.60.

1. Power down the ACTpro Controller.
2. **Important:** *Ensure nothing is connected to the tamper input terminal and the tamper spring is not pressed, otherwise the following steps will factory default the controller losing all information.*
3. Set the DHCP DIP switch 1 to **OFF**
4. Set the DEFAULT DIP switch 2 to **ON**.
5. Re-apply power - Wait approximately 5 seconds, until the controller confirms default completed by sounding the buzzer.
6. Remove power.
7. Set the DEFAULT DIP switch 2 to **OFF**.
8. Re-apply power. Note: The static IP address can be changed via the web interface or using ACT Software.

### 4.4 Changing Static IP address on the ACTpro Controller

1. Connect ACTpro Controller to the IP network.
2. Open Web browser on PC (use Microsoft Internet explorer, Chrome, etc.)
3. Enter `http://ACT1520E-(NetBIOS address)`  
e.g. `http://ACT1520E-07116`
4. Logon details:  
Username: **installer**  
Password: **999999**
5. Choose Communication menu and set the following:
  - **Static IP Address**
  - **Network Mask**
  - **Default Gateway**
6. Press Save.  
**Note:** use the new IP address when connecting to the controller.

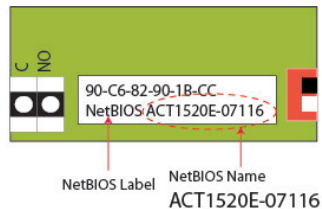

<b>Controller Address</b>	1
<b>Static IP</b>	192.168.1.60
<b>Network Mask</b>	255.255.255.0
<b>Default Gateway</b>	192.168.1.254
<b>MAC Address</b>	90:c6:82:90:1b:cc
<b>NetBIOS Name</b>	ACT1520E-07116
<b>TCP Port Num 1</b>	10001
<b>TCP Port Num 2</b>	10003
<b>DHCP Enabled</b>	Enabled
<b>DHCP Address</b>	172.27.1.82

## 5.0 Configuring the PC/Laptop for Static IP address

For Microsoft Windows 7 users; go to Start and enter the “**Network and Sharing**” in the search box.

For Microsoft Windows 8 or 10 users; start typing “**Network and Sharing**” from the main screen.

1. Select “**Network and Sharing Centre**”.
2. Select “**Change adapter setting**” and Right click on the “**Local Area Connection**” and select “**Properties**”.
3. Highlight “**Internet Protocol Version 4 (TCP/IPv4)**” and press the “**Properties**” button.
4. Select “**Use the following IP address**” and enter the following:  
Set IP address to “192.168.1.61”  
Subnet mask to “255.255.255.0”
5. Press OK then Close.

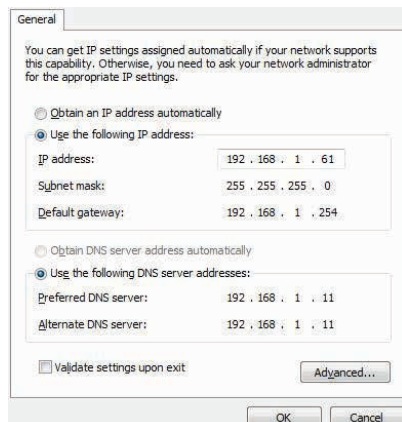
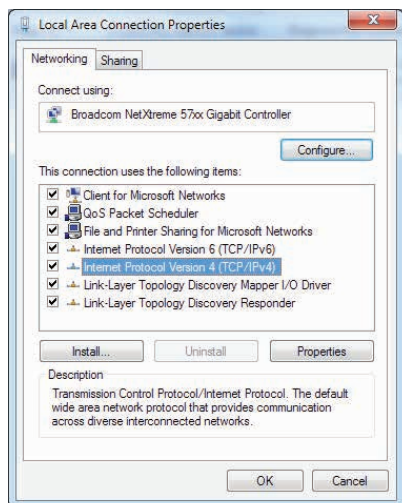
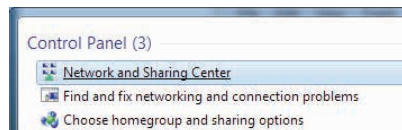

## 6.0 ACTpro 1520e/1500e Controller Status Indicators



### **Blue: Power**

This indicates that the ACTpro 1520e/1500e has power.



### **Blue: Communications**

**Constant illumination** indicates that all enabled door stations are online.

**Flashing** indicates that one or more door stations are offline.



### **Red: Fault**

This illuminates to indicate a fault on the system.

### **Possible causes are:**

1. Tamper open: ACTpro Controller housing is not closed.
2. Break Glass: ACTpro Controllers provide a method to monitor an Emergency break glass switch via the B/GL input. The fault LED will illuminate if the Emergency break glass switch is activated.
3. Mains Fault: ACTpro 1500e Controller will accept a mains present signal from a PSU (pre-wired on ACTpro 1520e). This is wired into MAINS PRESENT input on the PCB. When the PSU has no mains supply the fault is active.
4. Door Station offline: When one or more enabled door stations are not communicating with the ACTpro Controller the Fault LED illuminates and the appropriate network green LED on the PCB will flash.
5. Low Supply Voltage: When voltage to the +12V terminal is less than +9V.
6. Fuse Blown: The +12V output on the READER terminals is current limited to provide short circuit protection. The Fault LED will illuminate if too much current is drawn from this connection.

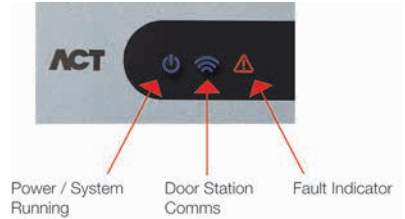

## 7.0 Installing ACT Enterprise

The ACTpro Controller can be configured and managed by ACT Enterprise software. ACT Enterprise software must be used on sites with more than one ACTpro Controller. Before installing ACT Enterprise software ensure the user account has sufficient rights to install applications.

### 7.1 Download and extract the setup program

ACT Enterprise software can be downloaded from [www.act.eu](http://www.act.eu) website. You must be registered (via the interACT portal on [act.eu](http://act.eu)) with ACT which is a simple process and free of charge.

Extract ACT Enterprise into a folder on the computer.

### 7.2 Installing ACT Enterprise

Right click on ACTEnterpriseSetup file and select “run as administrator” and follow the on-screen instructions to complete the installation.

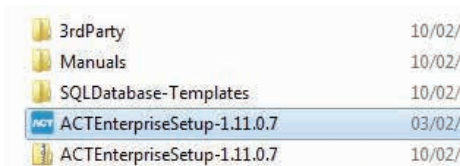

ACT Enterprise Lite is licensed for a single computer and up to 100 doors. ACT Enterprise pro is unrestricted and includes Sitemaps and Multi-tenant.

ACT Enterprise is compatible with all supported professional versions of Microsoft operating systems. For systems with more than one PC, ACTEnterprise must be installed in a Windows domain.

Operating System	ACTEnterprise Pro	ACTEnterprise Lite
Microsoft Vista - 32 & 64 bit	Yes	Yes
Microsoft Windows 7 - 32 & 64 bit	Yes	Yes
Microsoft Windows 8 - 32 & 64 bit	Yes	Yes
Microsoft Windows 10 - 32 & 64 bit	Yes	Yes
Microsoft 2008 Server professional - 32 & 64 bit	Yes	Yes
Microsoft 2012 Server professional - 32 & 64 bit	Yes	Yes

## 8.0 Add controllers to ACT Enterprise

**ACT Install** software is used to add and configure ACTpro Controllers. Before adding new ACTpro Controllers it is important the controller is powered up on the customers LAN and has a valid IP address. See section “**4.0 Defaulting Controller and IP Address Configuration**” to address the controller.

Launch **ACT Install** from “**Start | All programs | Access Control Technology | ACT Enterprise**” or launch from the ACT Install icon on the desktop.

Login to ACT Install; default username is **Administrator** and there is no password.

### Option1: Autodiscover controllers

Use Autodiscover if the controller is on the same network segment as the PC. Clicking **Autodiscover** searches the LAN for any ACTpro controllers, this may take several minutes. Autodiscovery can be run from “**ACTinstall | QuickSetup | Autodiscovering**”

The Autodiscover returns a list of controllers with the NetBIOS name. Select the discovered controllers; click “**Add New**” then “**Next**” and “**Finish**”. See figure 1.

Figure 1

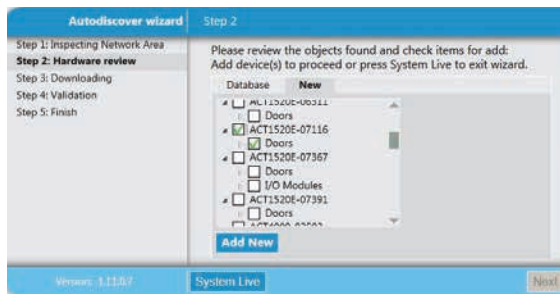
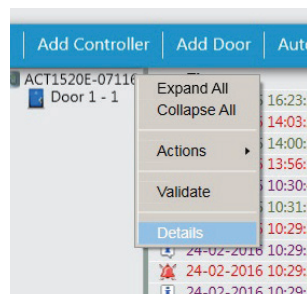

Figure 2



Go to **System Live**, right click on the controller name and select the **Details** option from the dropdown menu. See figure 2.

Change the name for the controller. ACT recommends a name that describes the location of the controller. See figure 3.

Figure 3

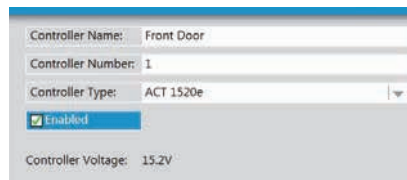

## Option2: Manually add controllers

### ACT Install | Advanced Setup | Controller/Hub Groups | Add controllers

(on the top right of screen).

1. **General Tab:** ensure the controller is enabled and named appropriately. ACT recommends a name that describes the location of the controller.

General	
Communications	Controller Name: Front Door
Doors	Controller Number: 1
I/O Modules	Controller Type: ACT 1520e
Output Options	<input checked="" type="checkbox"/> Enabled
Operations	Controller Voltage: 15.2V
Capabilities	
Cluster	
Firmware	

2. **Communication Tab:** enter the IP address or NetBIOS name of the controller and click **Test Connection**.

Communications Master	
<input checked="" type="radio"/> Direct to ACT Enterprise	
<input type="radio"/> Hubbed to Controller	
Connection Type:	TCP/IP
IP address:	ACT1520E-07116
Port:	10001
Encryption Key:	0
World Time Zone	Greenwich Mean Time
Web Page	<a href="http://ACT1520E-07116">http://ACT1520E-07116</a>
<b>Test Connection</b>	

Press **SAVE**.

Perform a system synchronise **ACT Install | Tools | System Synchronise**.

## 9.0 Backup/Restore from ACT Enterprise

**Caution:** Before any major change always perform a full system backup.

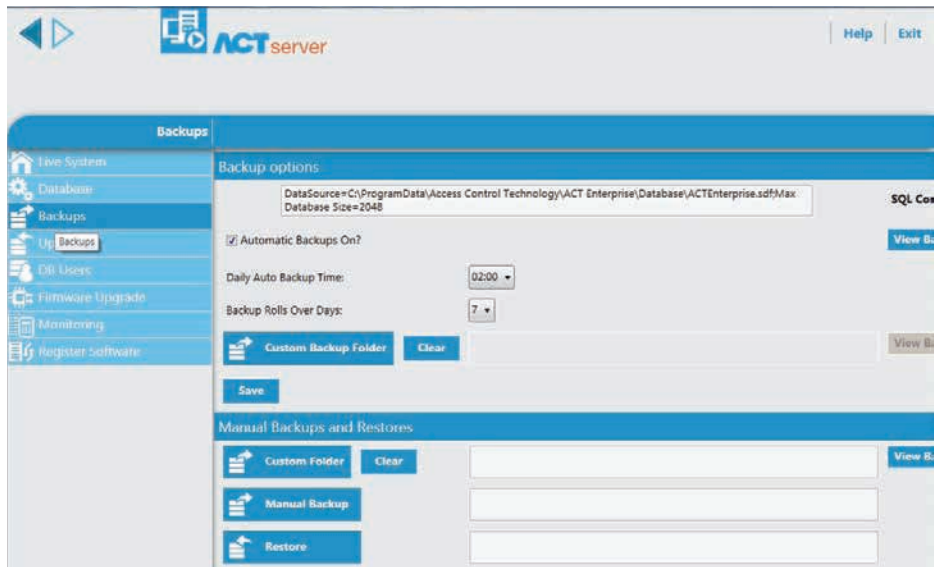

Database Backup and Restore are performed from the **Server Client** application, **Backups** tab.

Launch **ACT ServerClient** application from “**Start | All programs | Access Control Technology | ACT Enterprise**” or launch from the ACT ServerClient icon on the desktop.

**Note:** *If the access control database is a Microsoft SQL server, ACT recommend you use the native SQL backup and restore tool.*

**Manual Backup** performs an instant backup.

**Automatic Backups** performs a backup at the scheduled time.

## 10.0 Troubleshooting

### Unknown Card

The card has not been assigned on the system.

### Access Denied

Make sure the User is enabled and has appropriate access rights.

### Cannot Connect to ACTpro 1520e/1500e Controller

Step 1: On the Controller PCB check that the Green LINK LED (on the ethernet jack) is active; if inactive check the network point is connected to a switch.

Step 2: Ensure IP address has been set correctly (see section on IP Address Configuration).

Step 3: Ping the Controller using

- NetBIOS name e.g.  
**"ping act1520e-07116"**
- IP address e.g.  
**"ping 192.168.1.60"**

Use the last 5 digits from the NetBIOS label on the PCB as illustrated.

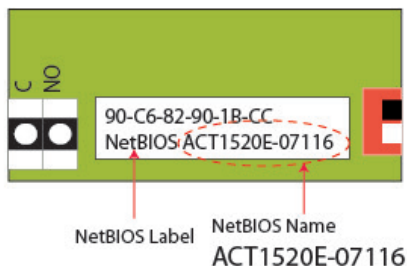

**If the problem is not resolved contact the IT department as there may be a problem with the network.**

### Door Station Offline (ACTpro 120e/100e)

Ensure Door is enabled.

Ensure correct address is assigned to the Door Station, using DIP switches.

Ensure the doors network is in a daisy chain wiring configuration.



## 11.0 ACTpro 1520e Installation & Technical Specification

The power supply is capable of delivering 2A. 1.5A is available for external locks and readers, 0.5A for the PCB and battery.

Electrical Specification:	
Input Voltage	230VAC +/- 10%
Frequency	47-53 Hz
Input Fuse	625mA 250V anti-surge fuse
Output Voltage	13.65V (+/- 5%)
Max Load	2A @ 25°C
Electronic Output fuse	Yes
Battery Current	~ 0.5A for a battery discharged to ~ 10V
Battery Protections	Deep Discharge/Over Charge/Reverse Polarity

### PSU Output Voltage:

#### 12V DC

The power supply provides two 12V outputs. One is pre-wired to power the ACT Controller. The second is available to power locks.

The full load current shared between the two outputs. ACT recommend that a **maximum of 1.5A** is used to power locks and readers. The remaining 0.5A is used by the controller and battery charging. Total current from both outputs must not exceed 2A.

### Monitoring:

#### Mains present

The PSU MAINS PRESENT output is pre-wired to the MAINS PRESENT input of the ACTpro 1520e Controller.

#### Output Voltage

The PSU output voltage level is reported to the ACT Enterprise software and on the web browser.

#### Tamper

The enclosure lid is tamper monitored.

#### Note:

*All faults including Mains Present and Tamper are reported on the ACT Enterprise Software and via the web browser on the ACTpro 1520e and 1500e controller.*

## LED indicators

Green - <b>AC OK</b>	Indicates that the AC Mains is within specification.
Amber – <b>ON BATTERY</b>	Indicates that the battery is supplying the output voltage.
Red - <b>FUSE FAULT</b>	Indicates electronic output shutdown fuse is active and that no power is being supplied to the load.

The maximum current that the PSU can guarantee is 1.5A plus 0.5A for battery charging. Beyond this the fuse will trip and the LED will stay on until the load is fully disconnected.

Once the load has been disconnected, remove devices to reduce the current demand below 1.5A.

It is important to calculate the power budget adequately. Please refer to the section on the following page titled 'Power Budget' for more information.



## Installation Instructions

The ACTpro 1520e/1500e Controllers are for indoor installation only and must be installed as permanently connected equipment.

An external mains disconnect device must be fitted. Before installation ensure that the mains supply to the controller is disconnected.

Mains power should be connected to ACTpro Controllers by a licensed electrician in accordance with local/national codes.

## Mounting

Mount the controller directly on to the wall with the supplied screws.

The keyed mounting hole should be screwed first to the wall to aid the mounting.

The unit should be installed in a ventilated area that allows for accessibility after installation.

## Mains Power up

Attach a correctly rated mains cable and fasten using the cable tie.

Use an approved external mains disconnect device.

Apply mains power. Check the 'AC OK' LED is on and measure the +12V output.

## Battery insertion

Disconnect the mains.

Ensure the battery has enough charge to supply the load.

Connect the red battery lead to the "+" battery terminal and the black lead to the "-" terminal.

Apply the mains power and check the "AC OK" Green LED is illuminated.

Remove the mains power and check that "ON BATTERY" Amber LED is illuminated. If the Amber led is illuminated the battery is now supplying the output.

Re-apply the mains power. The "AC OK" Led will illuminate and the "ON BATTERY" LED will extinguish.

## Power Budget

The PSU can supply up to 2A; 0.5A reserved for battery recharging and to power the controller. 1.5A remains to power the locks and readers.

A complete access control system will require readers and a lock mechanism all of which will require power.

The following table should be used for calculating the power budget.

ACTpro reader (1030/1040/1050/1060)	100mA
ACTPro MIFARE reader (1030/1040/1050)	100mA
Typical Mag Lock (consult your supplier)	800mA

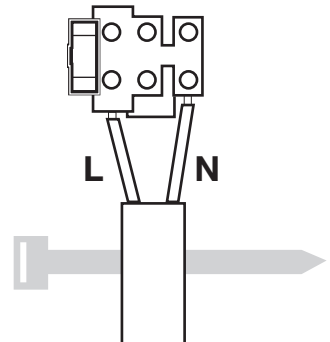

## 12.0 Fire Override Configuration



To release doors on fire alarm activation.

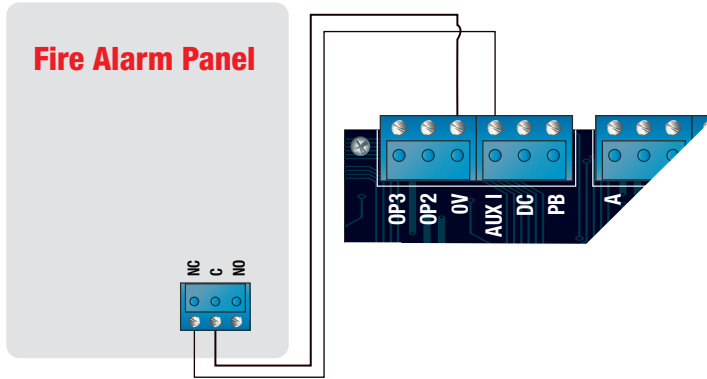

While the 0V signal is maintained at the AUX input on Door 1, the doors in the Fire Doors group maintain normal operation. The “**Fire Override Doors**” is selected in “**ACTmanage | Settings | Doors**”

When the 0V signal is removed, the doors are unlocked, and remain unlocked until the 0V is restored.

To set the Fire Doors group, go to ACT Install.

## 13.0 Interlock/Airlock Configuration

Allowing only one door to open at a time.

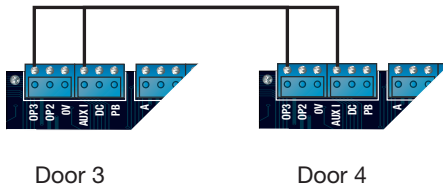

Door 3

Door 4

The diagram above shows how to interlock two doors. When Door 3 is open, Door 4 is locked and vice versa. Enable Interlock on each door using ACT Install.

To Interlock additional doors, simply continue linking OP3 and AUX I for each new door, as per illustration.

When Interlock is enabled on a door, the door is locked when the AUX input is active.

When the door is open, OP3 is active.

To enable “**Interlock**” “**ACT Install | Advanced Setup | Doors | <door#> | Operations**”

## 14.0 Intruder Panel Wiring Diagram

To arm/disarm intruder panel.

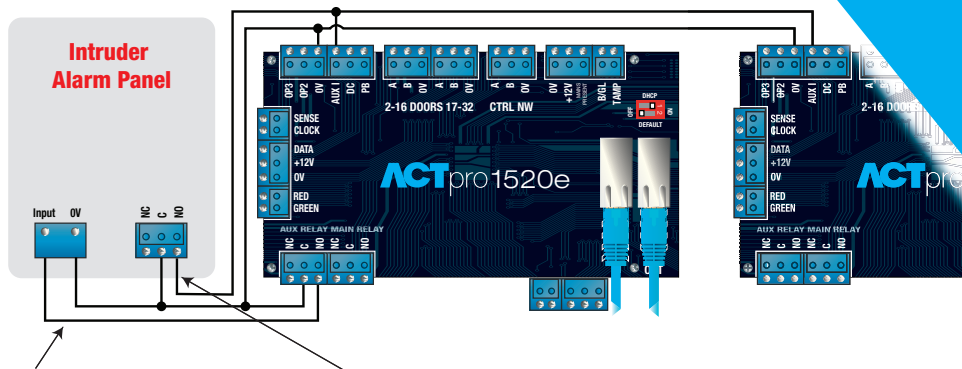

Connect AUX Relay output from the controller to arm input on alarm panel. The AUX relay can be set to pulse or toggle. Toggle by programming the AUX Relay time to zero.

Optional signal from the alarm panel to indicate armed or disarmed status. If 0V is connected to AUX Input, the panel is armed.

### Steps to Program the ACTpro Controller for ARM/DISARM

1. Complete the wiring in the diagram for the door that the system will be Arm/Disarmed from.
2. **"ACT Install | Advanced Setup | doors | <door#> | AUX Relay"** enable **'Arm Intruder Panel'**.
3. If the Alarm Panel provides a signal to indicate it's arm/disarm status then **"ACT Install | Advanced Setup | doors | <door#> | Operation"** enable **'Intruder Panel'**.
4. From **"ACTmanage | Manage | Users"** select the users that will be allowed to arm and disarm the panel and set the option **"ARM/DISARM"**. Make sure the user is enabled.
5. **"ACT Manage | Manage | Users | <user> | Options"** and enable **'Arm/Disarm'**.
6. The User can arm the system at the reader by first pressing the "tick" key followed by presentation of a card. Once the intruder panel is armed (as monitored by the AUX I PIN) the Door will lock.
7. Disarming is achieved by again pressing the "tick" key and presenting the Card.

NOTE: If multiple doors are required to lock when the intruder panel is armed then it is required that each door monitors the alarm status. If the intruder panel is not being monitored then only the door that is wired to control the intruder panel will lock.

## 15.0 Product Specification

### Features:

Built-in web server (only for use with single ACTpro 1520e or 1500e)
DHCP / Static IP addresses, dual Ethernet Switch
Voltage monitoring
Break glass monitoring
NetBIOS name
Status LED's
Space for cable management
Entry & exit readers
Reader short circuit protection
Anti-passback
Interlocking
TCP/IP connection for ACTEnterprise software or built-in Web Server
Main relay for door control and AUX relay for alarm monitoring
Supports all ACTpro readers (RFID 125Khz, MIFARE Classic, DESFire EV1)
Controls up to 32 doors via door stations and up to 4 IO Modules

### Capabilities:

Number of doors	1
Number of Users	60,000 (4 credentials per user)
User Groups	1,000
Time Zones	250
Door Groups	1,000
Log Events	5,000
Browser Compatibility	Microsoft Internet Explorer 8 or later, Chrome, Firefox Version 8.0

### Technical Details:

Voltage Range:	11-15V DC
Current Consumption (Controller)	350mA (Max)
Dimensions: (1520e Controller)	235mm x 255mm x 85mm
Weight: (1520e Controller)	950g
Dimensions: (1500e Controller)	235mm x 165mm x 55mm
Weight: (1500e Controller)	465g
Relay contacting rating	Main relay 5A / 50 Vac, AUX relay 1A / 50Vac
Operating temperature	-10 to +50° C
Indoor use only	

## 16.0 Ordering Information:

ACT Product Code	Product Description
<b>Controllers</b>	
ACTpro 1520e	ACTpro 1520e controller with integrated 12 V DC 2Amp power supply
ACTpro 1500e	Single door IP controller
<b>Software</b>	
ACTEnterprise Pro	PC application software unlimited door and unlimited PCs
ACTEnterprise Lite	PC software free download from <a href="http://www.act.eu">www.act.eu</a> up to 100 doors and one PC
<b>Readers</b>	
<b>ACT RFID</b>	
ACTpro 1030e	ACT RFID slimline, proximity reader, IP67
ACTpro 1040e	ACT RFID Surface / Flush, proximity reader, IP67
ACTpro 1050e	ACT RFID Surface/ Flush, PIN & proximity reader, IP67
ACTpro 1060e	ACT PIN only reader, IP67
ACTpro 1030PM	Panel mount RFID proximity reader, IP67
ACTpro 1030e VR	Vandal Resistant cover for the ACTpro 1030e
<b>ACTpro MIFARE</b>	
ACTpro MIFARE 1030	ACT MIFARE slimline, proximity reader, IP67
ACTpro MIFARE 1040	ACT MIFARE Surface / Flush, proximity reader, IP67
ACTpro MIFARE 1050	ACT MIFARE Surface/ Flush, PIN & proximity reader, IP67
ACTpro MIFARE 1030PM	Panel mount MIFARE proximity reader, IP67
ACTpro 1030 VR	Vandal Resistant cover for the ACTpro MIFARE 1030
<b>ACTpro DESFire EV1</b>	
ACTpro DESFire EV1 1030	ACT DESFire slimline, proximity reader, IP67
ACTpro DESFire EV1 1040	ACT DESFire Surface / Flush, proximity reader, IP67
ACTpro DESFire EV1 1050	ACT DESFire Surface/ Flush, PIN & proximity reader, IP67
ACTpro DESFire EV1 1030PM	Panel mount DESFire EV1 reader, IP67
<b>Cards and Fobs</b>	
ACT RFID ISO-B	ACT RFID Batch Cards
ACT RFID FOB-B	ACT RFID Batch Fobs
ACTpro MIFARE Card	ACT MIFARE 1K Cards
ACTpro MIFARE Fob	ACT MIFARE 1K Fobs
ACTpro DESFire EV1 Card	ACT DESFire EV1 Cards
<b>Accessories</b>	
ACT USB Reader	ACT USB Multi-format reader (MIFARE, DESFire EV1 and RFID); Compatible with ACT Enterprise

This manual refers to the ACTpro 1520e and ACTpro 1500e single door IP controllers. ACT recommend using ACT Enterprise 1.11.0.8 or Later.

Access Control Technology Ltd. reserve the right to change the contents of this manual and the system it applies to without prior notice.

While every effort has been taken by ACT to ensure the accuracy of the information contained within this document, ACT assumes no responsibility for any errors or omissions. No liability is assumed for damages resulting from the use of information contained within this document.

**Certifications:**

The ACTpro 1520e complies with the following European directives:  
Information technology equipment -  
Safety - EN60950-1  
EMC Directive - 2004/108/EC



Ireland Office  
Unit C1, South City Business Centre,  
Tallaght, Dublin 24, Ireland

United Kingdom Office  
Unit 601, Birchwood 1, Dewhurst Road,  
Birchwood, Warrington, WA3 7GB, UK

Ireland: +353 (0)1 466 2570  
UK: +44 (0)161 236 9488  
Email: [info@act.eu](mailto:info@act.eu)  
[www.act.eu](http://www.act.eu)

