



RoLP LX Wall Base



EN54-23 Fire Alarm Devices
Visual Alarm Device for use
in & around buildings

Dispositifs incendie EN54-23
Dispositifs Visuels Alarme Feu pour utilisation
à l'intérieur et autour des bâtiments

EN54-23 Feuermeldevorrichtung
Optischer Signalgeber zur Innen-
und Aussenmontage



DOP No.: 0333-CPD-075444



9-60VDC



1.5W (max)



2.4m (max)



	High Power		Low Power	
	1 Hz	0.5Hz	1 Hz	0.5Hz
White	W-2.4-7.5		W-2.2-2.3	
	7.5m (135m ³)		2.5m (15m ³)	
Red	W-2.1-2.2		W-2.1-2.2	
	7.5m (135m ³)		2.5m (15m ³)	



W-2.4-7.5
7.5m (135m³)



	12V	51mA	27mA	35mA	19mA
White Flash	12V	51mA	27mA	35mA	19mA
Flash Blanc	24V	25mA	16mA	16mA	10mA
Weisser Blitz	48V	18mA	11mA	11mA	9mA

	12V	51mA	27mA	35mA	19mA
Red Flash	12V	51mA	27mA	35mA	19mA
Flash Rouge	24V	25mA	16mA	16mA	10mA
roter Blitz	48V	18mA	11mA	11mA	9mA



< 120% for 10mS



100mS ON / 900mS OFF
50mS ON / 950mS OFF



0.5mm² - 2.5mm²



-25°C ~ 70°C



FR ABS & Polycarbonate



Type A & B
IP65

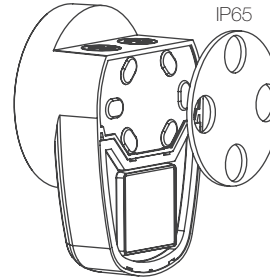
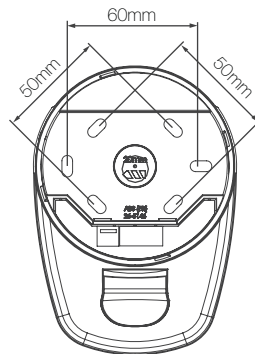
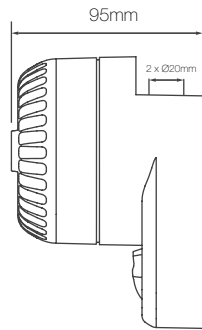
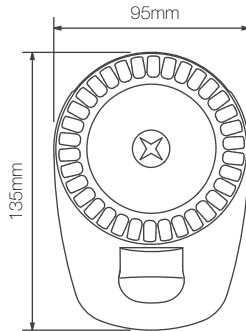

- Please use gasket on both sides.
- Un joint torique doit être utilisé de chaque côté.
- An jeder Seite muss ein dichtungsring angebracht werden.

- Drilling diameter must be adjusted to the diameter of the cable glands.
- Le diamètre de perçage doit être adapté au diamètre des presses-étoupes.
- Bohrdurchmesser muss dem Kabeldurchmesser angepasst sein.

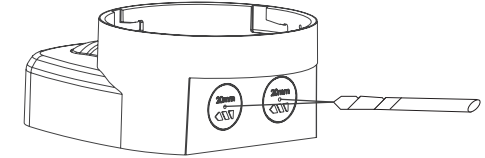

- Cable Glands must be compatible with declared cable size.
- Les presses-étoupes doivent être adaptés à la section des câbles déclarée.
- Kabeldurchführungen müssen mit den angegebenen Kabelabmessungen kompatibel sein.

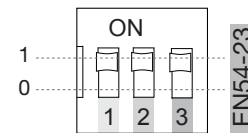
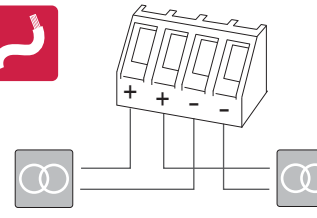
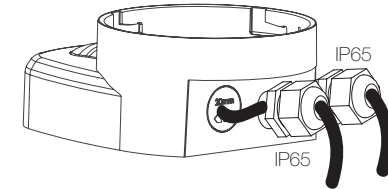

1Hz	1	Pass
0.5Hz	0	Pass



High Power	1	Pass
Low Power	0	Pass



White	N/A
-------	-----



Wall Mounted: W-2.4-7.5
Mural: W-2.4-7.5

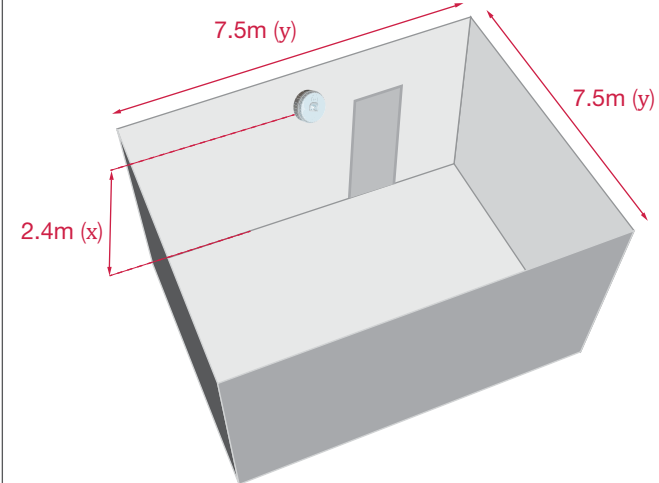

Product Manual M12-002
customerservice@cooperfulleon.com
01633 628566

25-11211-F

Essential Characteristics / Caractéristiques

Operational Reliability / Fiabilité de Fonctionnement	
Duration of operation / Durée de fonctionnement	PASS/CONFORME
Provision for external conductors / Disposition pour conducteurs extérieurs	PASS/CONFORME
Flammability of materials / Inflammabilité des matériaux	PASS/CONFORME
Enclosure protection / Indice de protection	PASS/CONFORME
Access / Accès	PASS/CONFORME
Manufacturer's adjustments / Réglages du fabricant	PASS/CONFORME
On-site adjustment of behaviour / Réglages du site	PASS/CONFORME
Requirements for software controlled devices / Exigences relatives aux dispositifs contrôlés par logiciel	PASS/CONFORME
Performance parameters under fire condition / Paramètres de performance en cas d'incendie	
Coverage Volume / Volume de couverture	PASS/CONFORME
Variation of light output / Variance de la puissance lumineuse	PASS/CONFORME
Minimum/maximum light intensity / Intensité lumineuse minimale/maximale	PASS/CONFORME
Light colour / Couleur de la lumière	WHITE/RED / BLANC/ROUGE
Light pattern & frequency of flashing / Effets temporels lumineux et fréquence de clignotement du flash	0.5/1Hz
Marking & Data / Marquage et données techniques	PASS/CONFORME
Synchronisation	PASS/CONFORME
Temperature Resistance / Résistance à la température	
Dry heat (operational) / Chaleur sèche (fonctionnel)	PASS/CONFORME
Dry heat (endurance) / Chaleur sèche (endurance)	PASS/CONFORME
Cold (operational) / Froid (fonctionnel)	PASS/CONFORME
Humidity Resistance / Résistance à l'humidité	
Damp heat, cyclic (operational) / Chaleur humide, cyclique (fonctionnel)	PASS/CONFORME
Damp heat, steady state (endurance) / Chaleur humide, continue (endurance)	PASS/CONFORME
Damp heat, cyclic (endurance) / Chaleur humide, cyclique (endurance)	PASS/CONFORME
Shock & Vibration & Resistance / Choc & Vibration & Resistance	
Shock (operational) / Choc mécanique (fonctionnel)	PASS/CONFORME
Impact (operational) / Impact (fonctionnel)	PASS/CONFORME
Vibration (operational) / Vibration (fonctionnel)	PASS/CONFORME
Vibration (endurance)	PASS/CONFORME
Corrosion Resistance / Résistance à la corrosion	
SO ₂ corrosion (endurance) / Corrosion par le SO ₂	PASS/CONFORME
Electrical Stability / Stabilité électrique	
EMC immunity (operational) / CEM Immunité (fonctionnel)	PASS/CONFORME

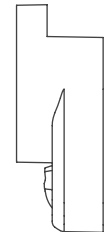
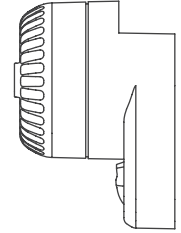
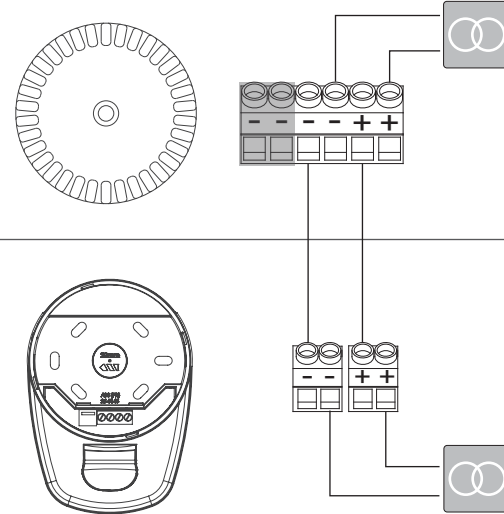

Synchronisation Synchronisierung

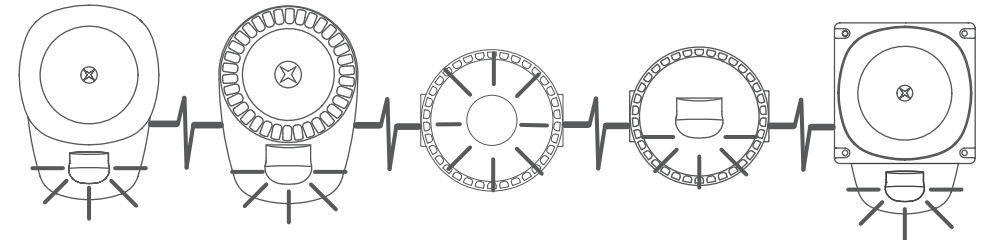

25-11211-F